

**ESTONIAN  
DEFENCE  
WEEK**

**TALLINN DEFENCE EXPO 2026**

**Stand configuration and  
customisation options  
Version 1.1**

# EVENT OVERVIEW & CONTACTS

**Event Title:** Estonian Defence Week 2026 – Tallinn Defence EXPO 2026  
**Event Dates:** 22-24 September 2026  
**Event Venue:** Tallinn Creative Hub (Kultuurikatel)  
**Website Link:** [www.edw.ee](http://www.edw.ee)  
**Version:** 1.0  
**Organised by:** Estonian Defence and Aerospace Industry Association  
[www.defence.ee](http://www.defence.ee)

## **Official Expo Vendor & Technical Partner:**

Kingent Management  
[www.kingent.ee](http://www.kingent.ee)

## **Expo Manager & Primary Contact:**

Merlyn Paomets  
[merlyn@kingent.ee](mailto:merlyn@kingent.ee)  
+372 5840 0583

## **General Inquiries & Backup:**

[expo@kingent.ee](mailto:expo@kingent.ee)  
+372 5557 5318

# INDOOR STAND TYPES BY ARENA

## ARENA A - CAULDRON HALL

- Standard 1 stand
- Back wall height: 2.5 m
- Custom designs are based on Standard 1 specifications.

## ARENA B - SMALL HALL

- Standard 1 stand
- Back wall height: 2.5 m
- Custom designs are based on Standard 1 specifications.

## ARENA C - ATRIUM HALL

- Standard 2 stand
- Back wall height: 2.3 m
- Custom designs are based on Standard 2 specifications.  
Arena C uses the lower Standard 2 structure due to Atrium Hall clearance requirements.

### Important

Single and double configurations follow the same arena-based stand family: Standard 1 in Arenas A and B, and Standard 2 in Arena C.

Custom graphics, additional branding and equipment must remain within the confirmed stand type, assigned footprint and venue safety requirements.

All designs are subject to Expo Manager approval.

**The deadline for submitting custom design files is 12 June 2026.**

# TALLINN DEFENCE EXPO 2026

## LAYOUT PLAN TALLINN CREATIVE HUB

### LEGEND

- Sponsors at the Outdoor Area and in the Atrium (S)
- Outdoor EXPO (F)
- EXPO Arena A in Cauldron Hall (01-40)
- EXPO Arena B in Small Hall (41-57)
- EXPO Arena C in Atrium Hall (58-74)
- Outdoor area fence

### ARENA B (Level 0) Access Points:

1. Main path from Accreditation Center.
2. Via Small Hall balcony from the Atrium (Level 1).

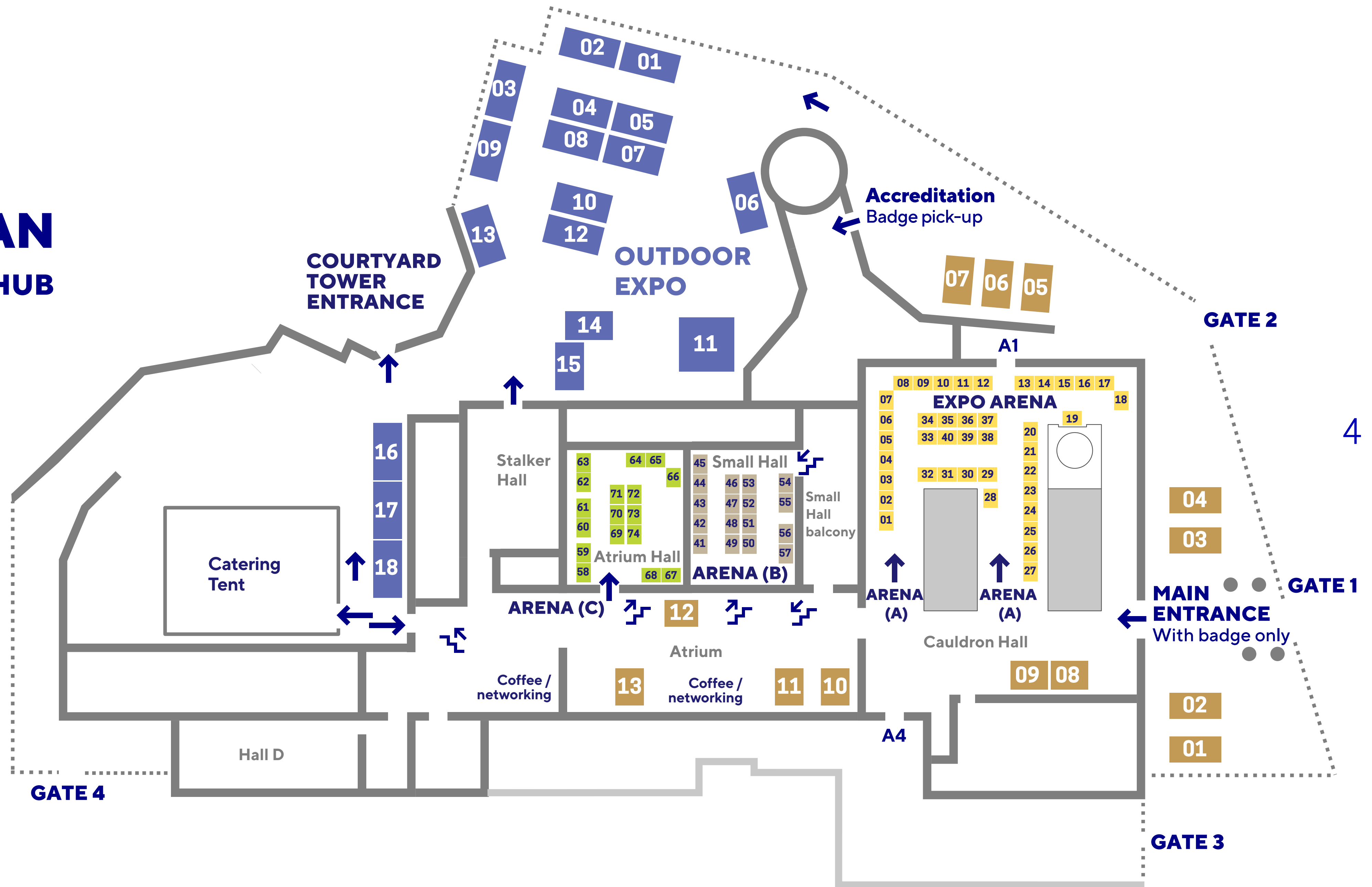

\* Provisional layout - subject to change.

# CUSTOM GRAPHIC DESIGN

## STANDARD 1 STAND

### Graphic design for back wall

- Dimensions: 2000 mm (W) × 2500 mm (H)
- Important: centre area will be covered by a 55" LCD screen.
- Mandatory: stand number placed in the upper-left corner.

### Graphic design for counter sides

- Front side: 965 mm (W) × 920 mm (H)
- Left and right sides (each): 470 mm (W) × 920 mm (H)

### Important note:

All edges of the counter graphics will be inserted approximately 5–7 mm into grooves. Avoid placing critical details or small text close to the edges. (See reference on page 5.)

## PRINT SPECIFICATIONS

- File: Print-ready PDF (preset: “Press Quality” or “PDF/X-1a:2001”)
- Colours: CMYK
- Bleed: 10 mm on all sides
- Fonts: Outlined (converted to paths); no live fonts
- Images: 100–150 ppi at final 1:1 print size.  
Artwork must be submitted at final production size. Reduced-scale files are accepted only by prior approval and must meet the required effective final resolution.

## STANDARD 2 STAND

### Graphic design for back wall

- Dimensions: 2000 mm (W) × 2300 mm (H)

## NOTE

Custom graphic designs for stands are available as an additional paid service. Please inquire with the EXPO team for details and pricing.

# STANDS

## STANDARD 1

- **Footprint:** 2.0 x 1.5 m
- **Height:** 2.5 m
- **Flooring:** Carpet with protective film
- **Power Supply:** 2 x Schuko sockets, 230 V, 16 A, 1.5 kW
- **Lighting:** LED ceiling lights, 300 lux, 4000 K
- **Exhibition counter:** 1.0 x 0.5 m, height 1.0 m
- **Seating:** 2 bar stools
- **Display:** 55" LCD screen with HDMI connection
- All areas marked in orange can be customised with your own graphics.

### STANDARD 1

All areas marked in orange can be customised with your own graphics.

Iso view

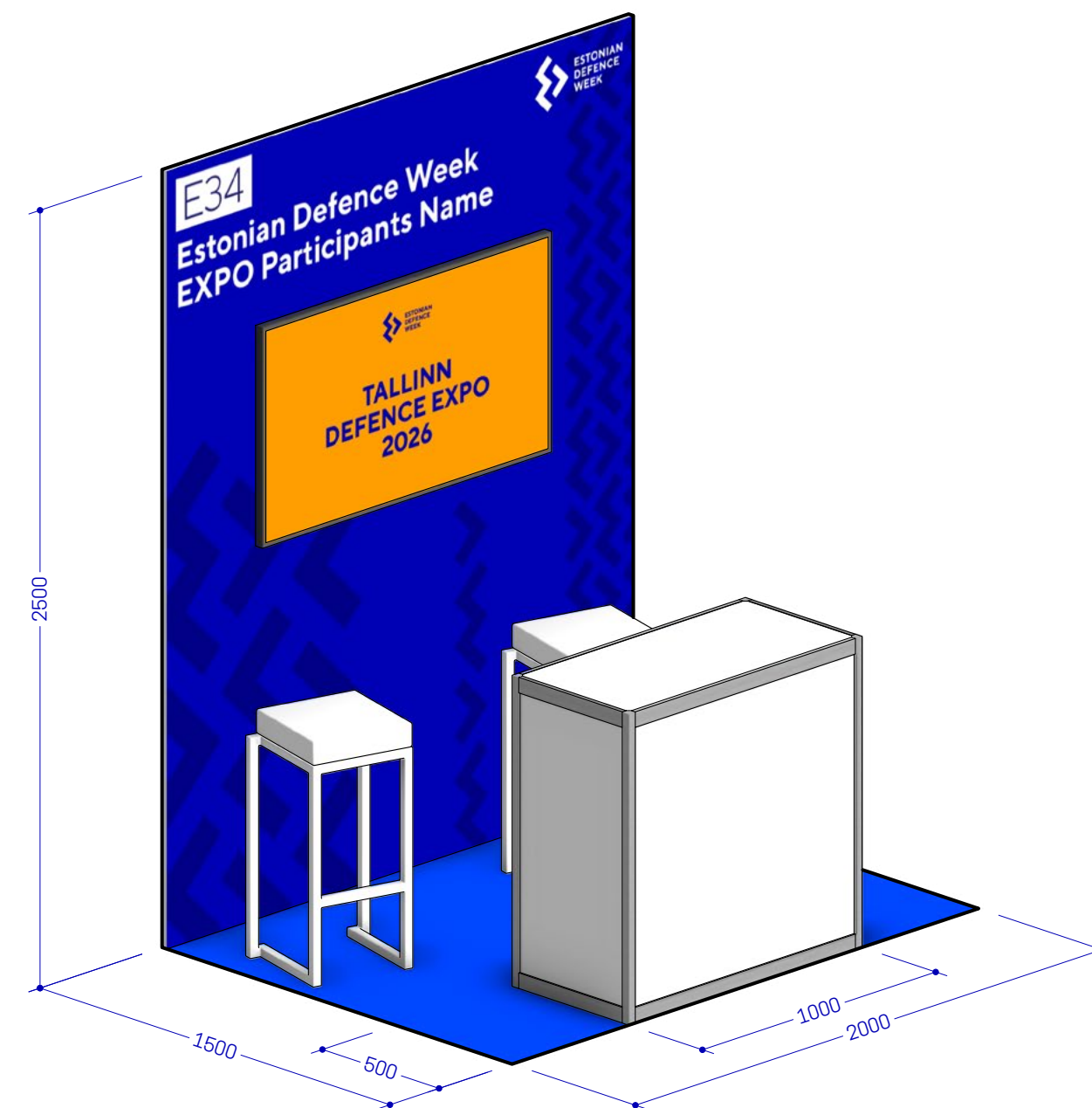

Front view

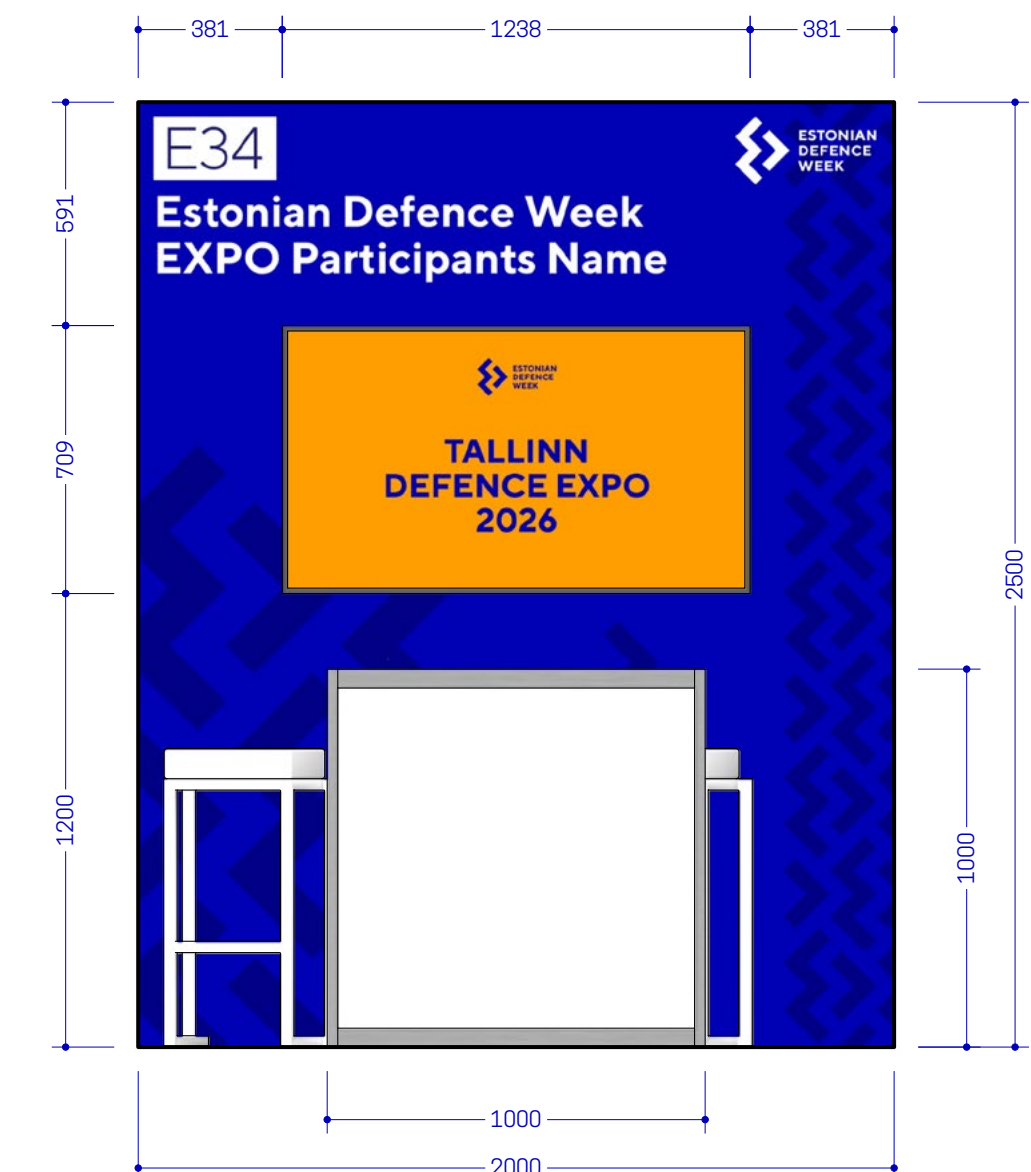

[www.kingent.ee](http://www.kingent.ee)  
A3 / M=1:20

# STANDS

## STANDARD 1 CUSTOM

- **Footprint:** 2.0 x 1.5 m
- **Height:** 2.5 m
- **Flooring:** Carpet with protective film
- **Power Supply:** 2 x Schuko sockets, 230 V, 16 A, 1.5 kW
- **Lighting:** LED ceiling lights, 300 lux, 4000 K
- **Exhibition counter:** 1.0 x 0.5 m, height 1.0 m
- **Seating:** 2 bar stools
- **Display:** 55" LCD screen with HDMI connection

### Custom graphic design option

Exhibitors may customise designated stand areas (marked in orange) with their graphics. All designs must meet event standards and require approval by the Expo Manager for consistency.

### Important:

The deadline for submitting graphic design files is 12 June 2026.

## STANDARD 1 CUSTOM

All areas marked in orange can be customised with your own graphics.

Iso view

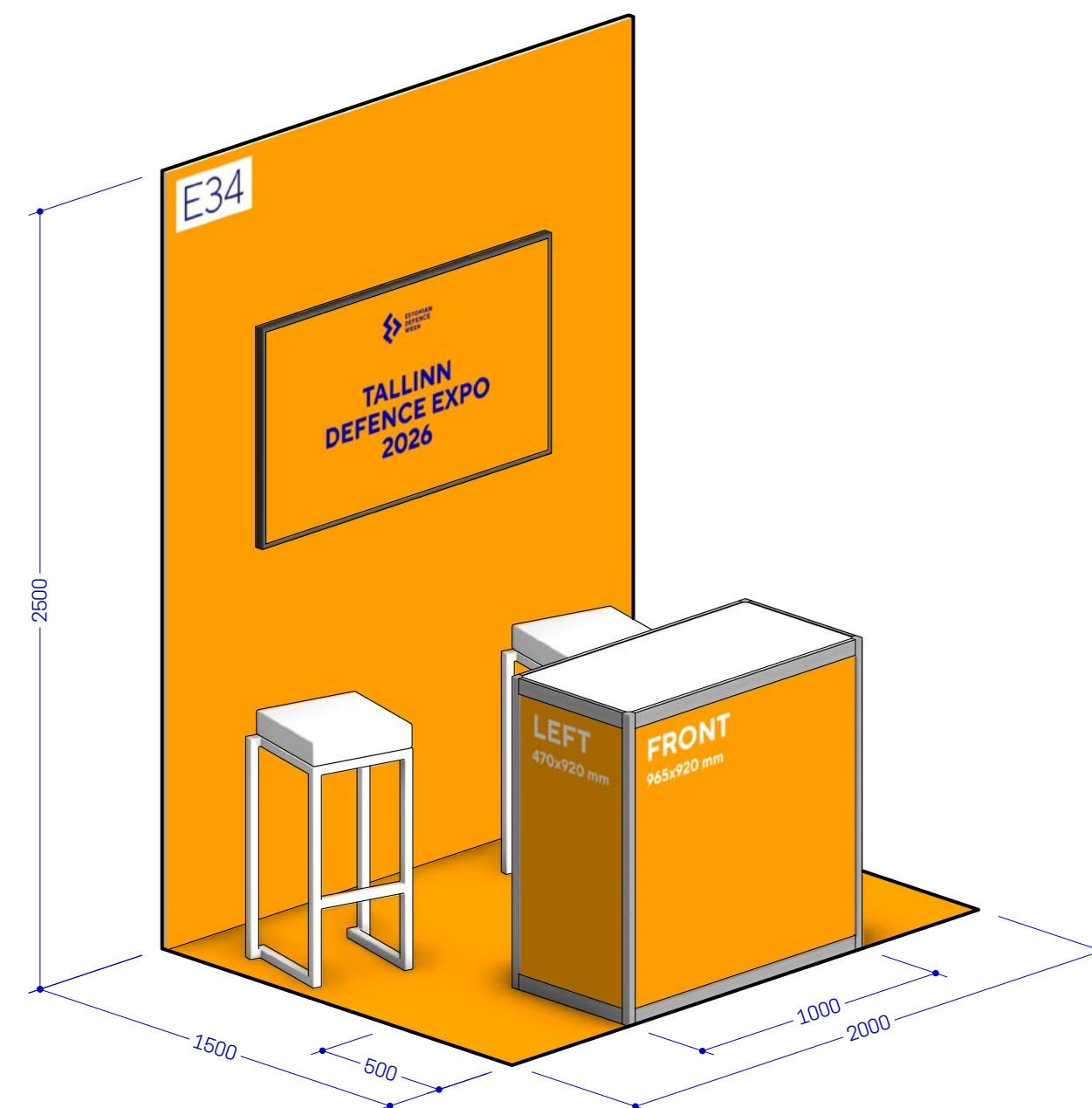

Front view

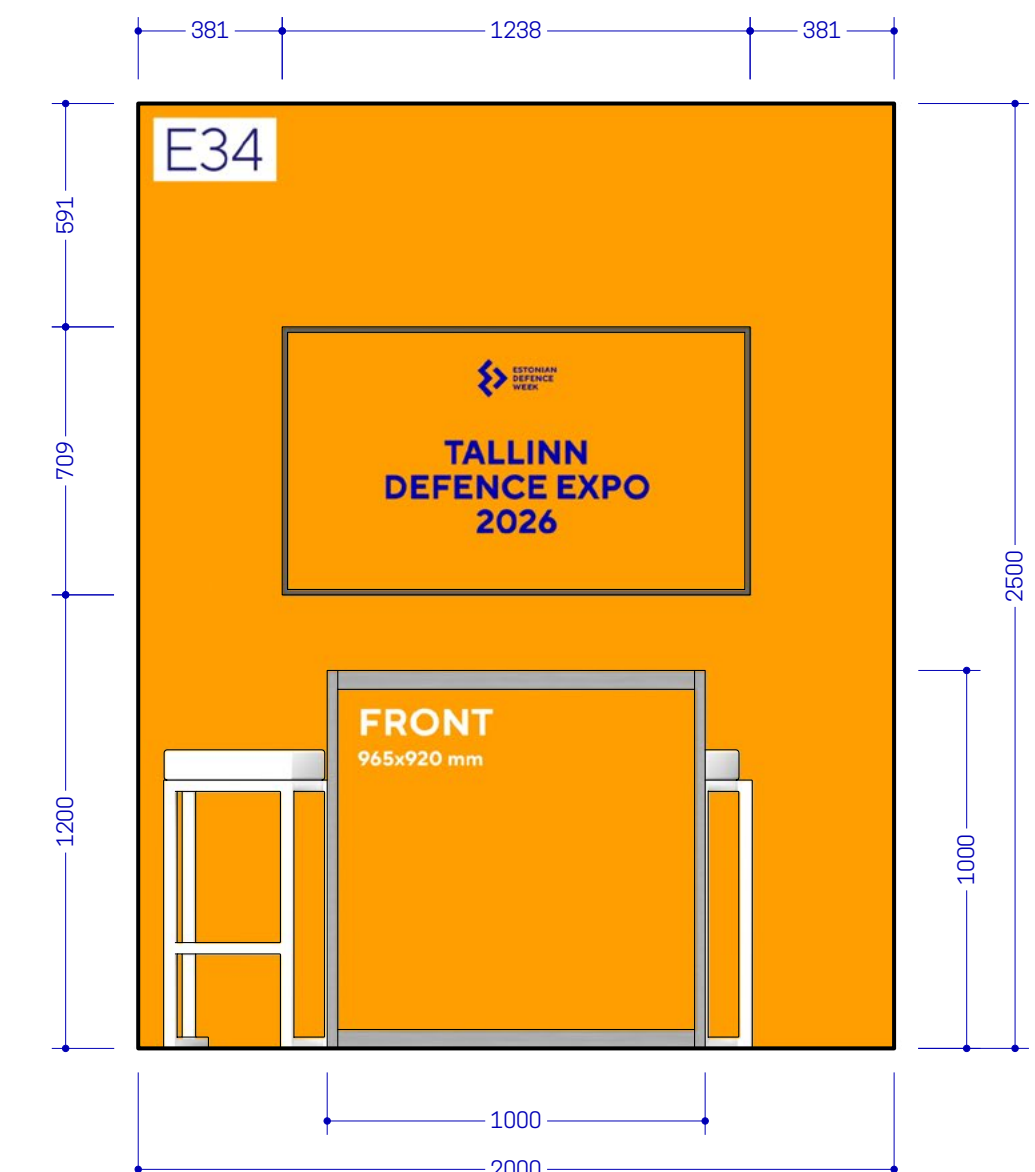

[www.kingent.ee](http://www.kingent.ee)  
A3 / M=1:20

# STANDS

## STANDARD 1 CUSTOM

### STANDARD 1 CUSTOM

All areas marked in orange can be customised with your own graphics.

#### 55" LCD



**Resolution**  
3840 x 2160 (16:9)

**Set Dimension (WxHxD)**  
1238 x 709 mm

**Active Display Area**  
1209.6 x 680.4 mm

#### Stand back wall

**NB!** Keep area under stand number and LCD clear of logos and text.  
Stand number sticker will be applied on-site.

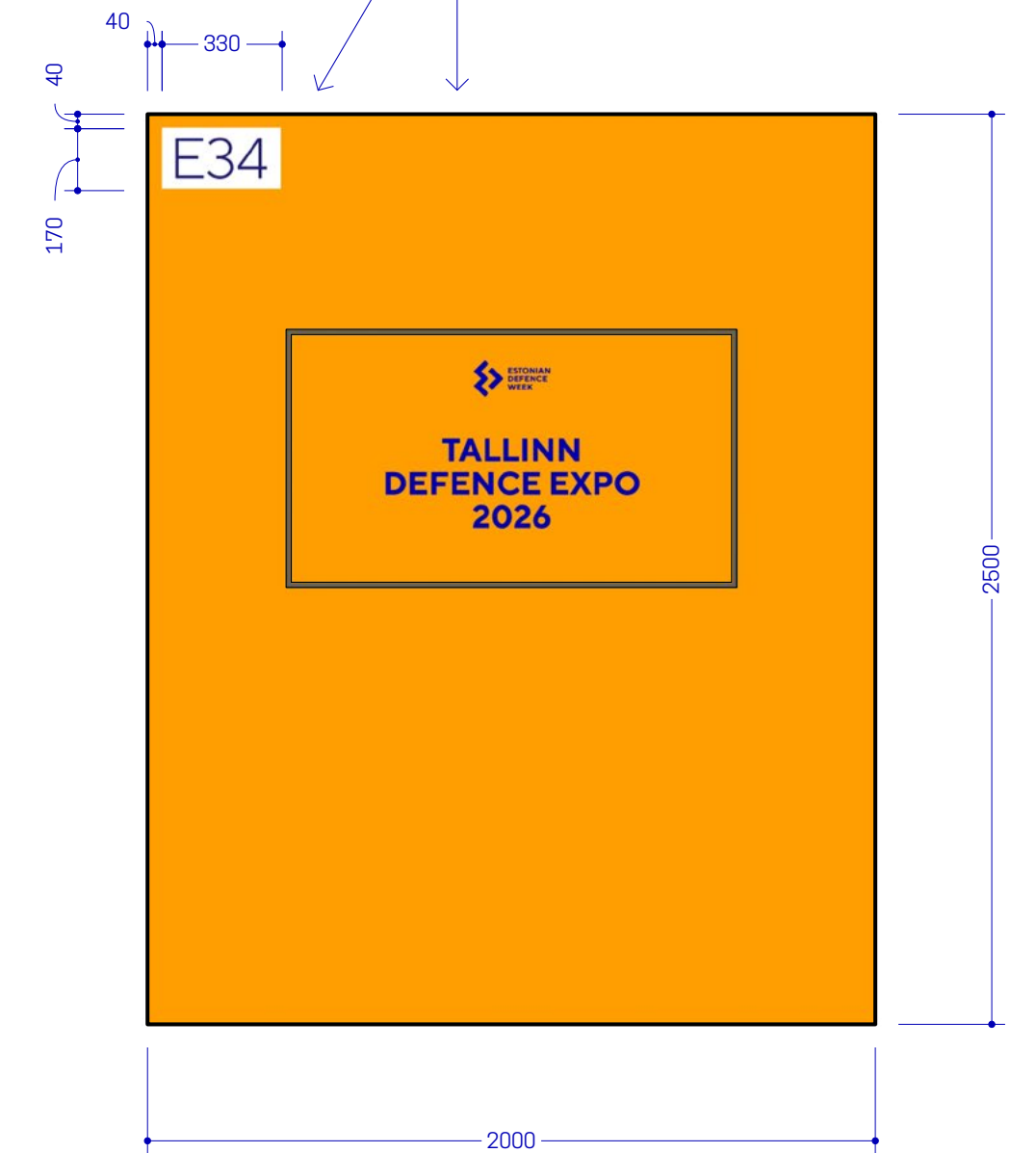

#### Exhibition counter

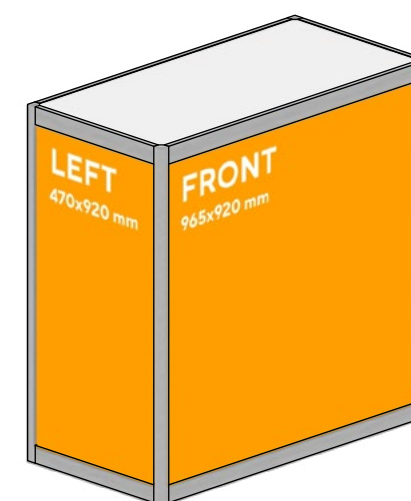

**Important note:**  
All edges of the counter graphics will be inserted approximately 5-7 mm into grooves.  
Avoid placing critical details or small text close to the edges.

[www.kingent.ee](http://www.kingent.ee)  
A3 / M=1:20

# STANDS

## STANDARD 1 DOUBLE

- **Footprint:** 4.0 x 1.5 m
- **Height:** 2.5 m
- **Flooring:** Carpet with protective film
- **Power Supply:** 4 x Schuko sockets, 230 V, 16 A, 1.5 kW
- **Lighting:** LED ceiling lights, 300 lux, 4000 K
- **Exhibition counter:** 2 counters (1.0 x 0.5 m, height 1.0 m)
- **Seating:** 4 bar stools
- **Display:** 2 x 55" LCD screen with HDMI connection
- All areas marked in orange can be customised with your own graphics.

### STANDARD 1 DOUBLE

All areas marked in orange can be customised with your own graphics.

Iso view

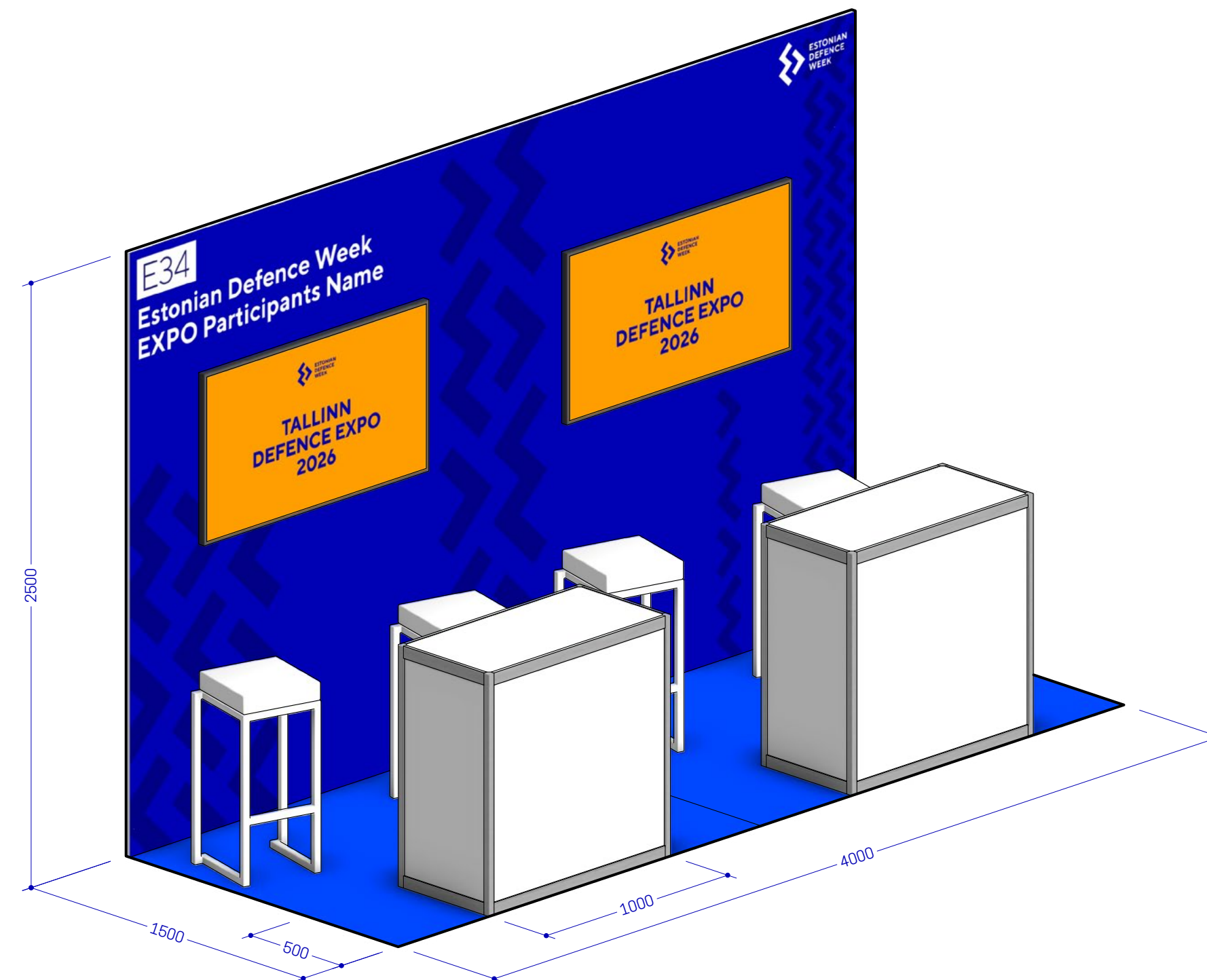

[www.kingent.ee](http://www.kingent.ee)  
A3/M=1:20

# STANDS

## STANDARD 1 DOUBLE

### STANDARD 1 DOUBLE

All areas marked in orange can be customised with your own graphics.

Front view

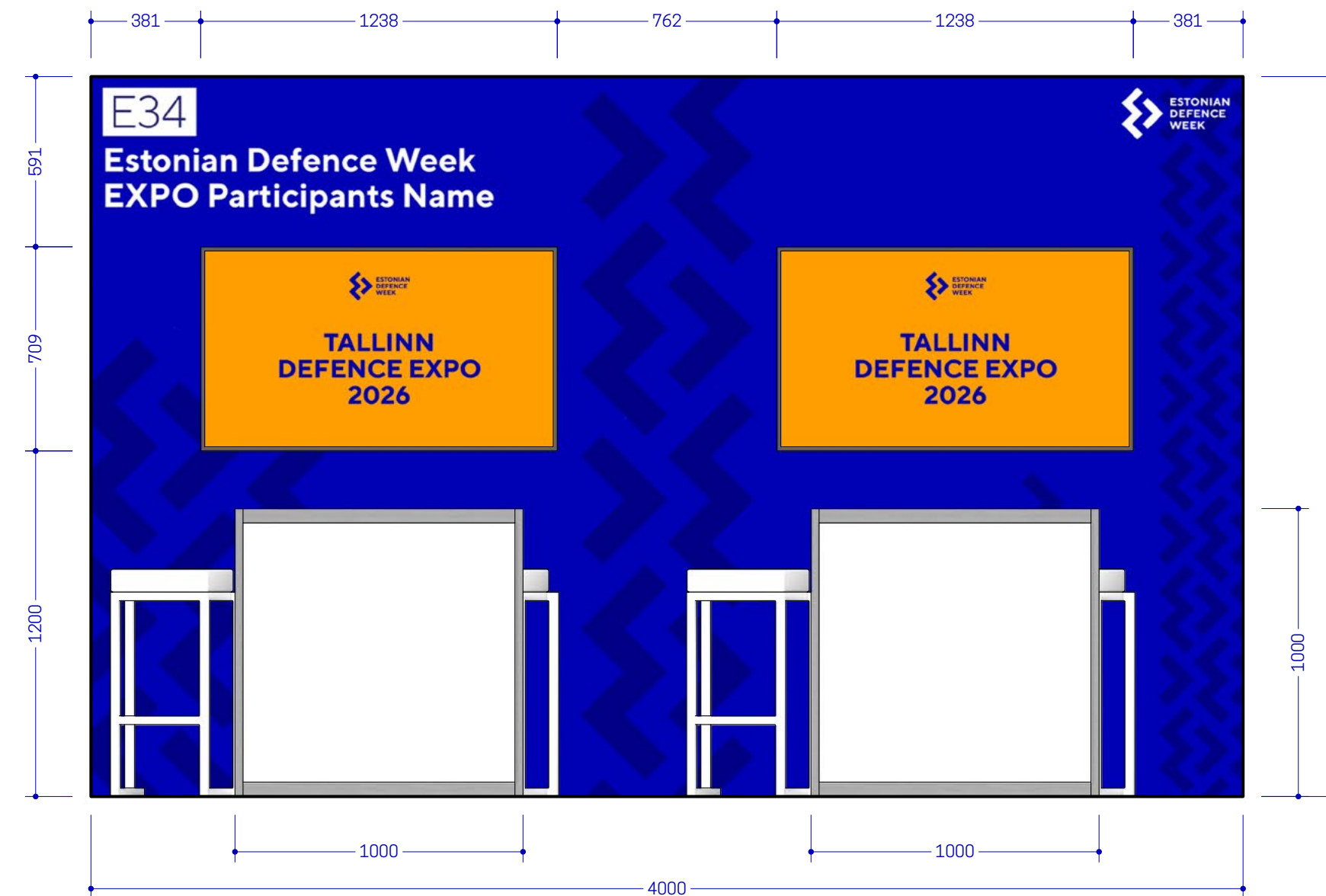

# STANDS

## STANDARD 1 CUSTOM DOUBLE

- **Footprint:** 4.0 x 1.5 m
- **Height:** 2.5 m
- **Flooring:** Carpet with protective film
- **Power Supply:** 4 x Schuko sockets, 230 V, 16 A, 1.5 kW
- **Lighting:** LED ceiling lights, 300 lux, 4000 K
- **Exhibition counter:** 2 counters (1.0 x 0.5 m, height 1.0 m)
- **Seating:** 4 bar stools
- **Display:** 2 x 55" LCD screen with HDMI connection

### Custom graphic design option

Exhibitors may customise designated stand areas (marked in orange) with their graphics. All designs must meet event standards and require approval by the Expo Manager for consistency.

### Important:

The deadline for submitting graphic design files is 12 June 2026.

### STANDARD 1 CUSTOM DOUBLE

All areas marked in orange can be customised with your own graphics.

Iso view

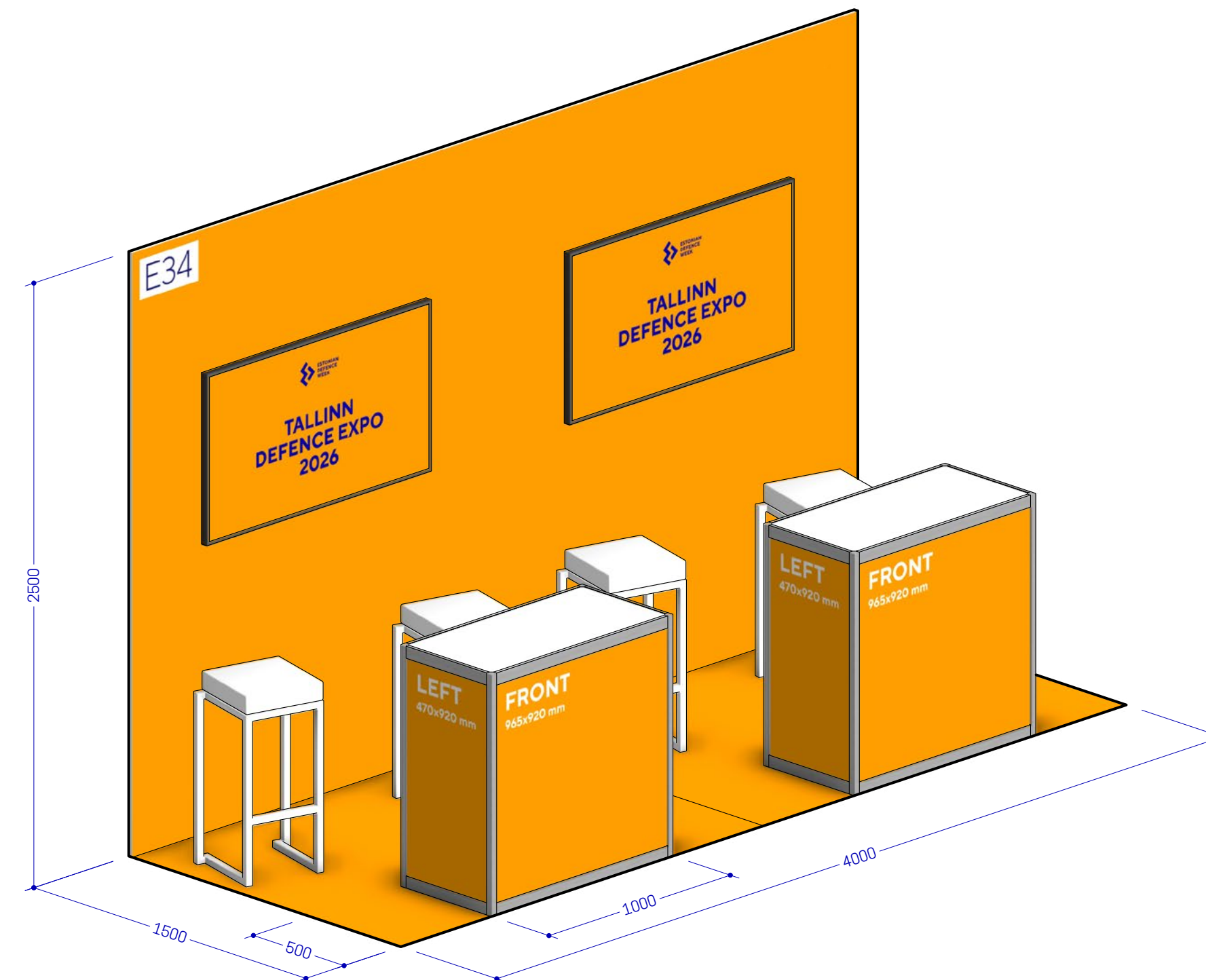

[www.kingent.ee](http://www.kingent.ee)  
A3 / M=1:20

# STANDS

## STANDARD 1 CUSTOM DOUBLE

### STANDARD 1 CUSTOM DOUBLE

All areas marked in orange can be customised with your own graphics.

Front view

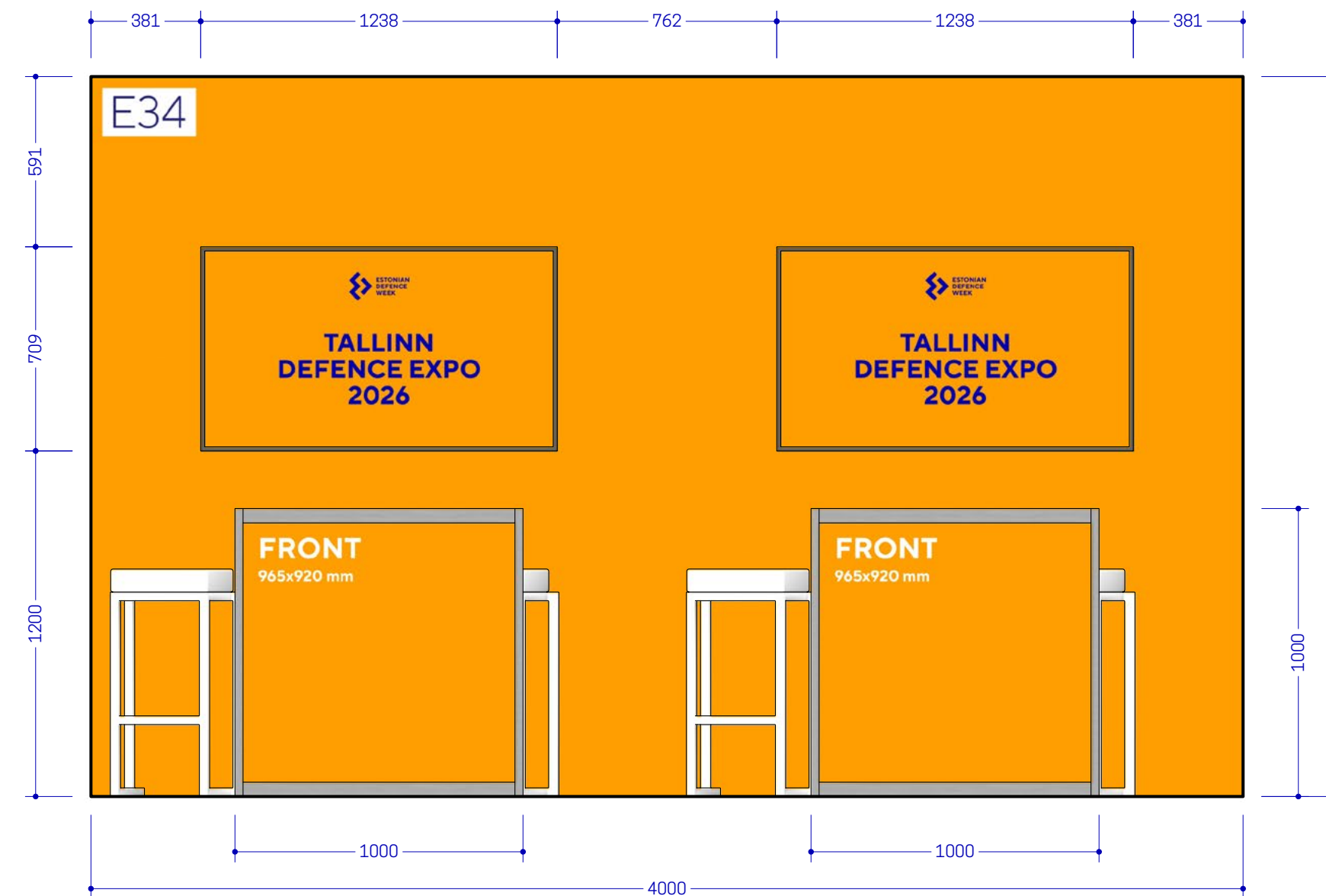

# STANDS

## STANDARD 1 CUSTOM DOUBLE

### STANDARD 1 CUSTOM DOUBLE

All areas marked in orange can be customised with your own graphics.

#### Stand back wall

**NB!** Keep area under stand number and LCDs clear of logos and text.  
Stand number sticker will be applied on-site.

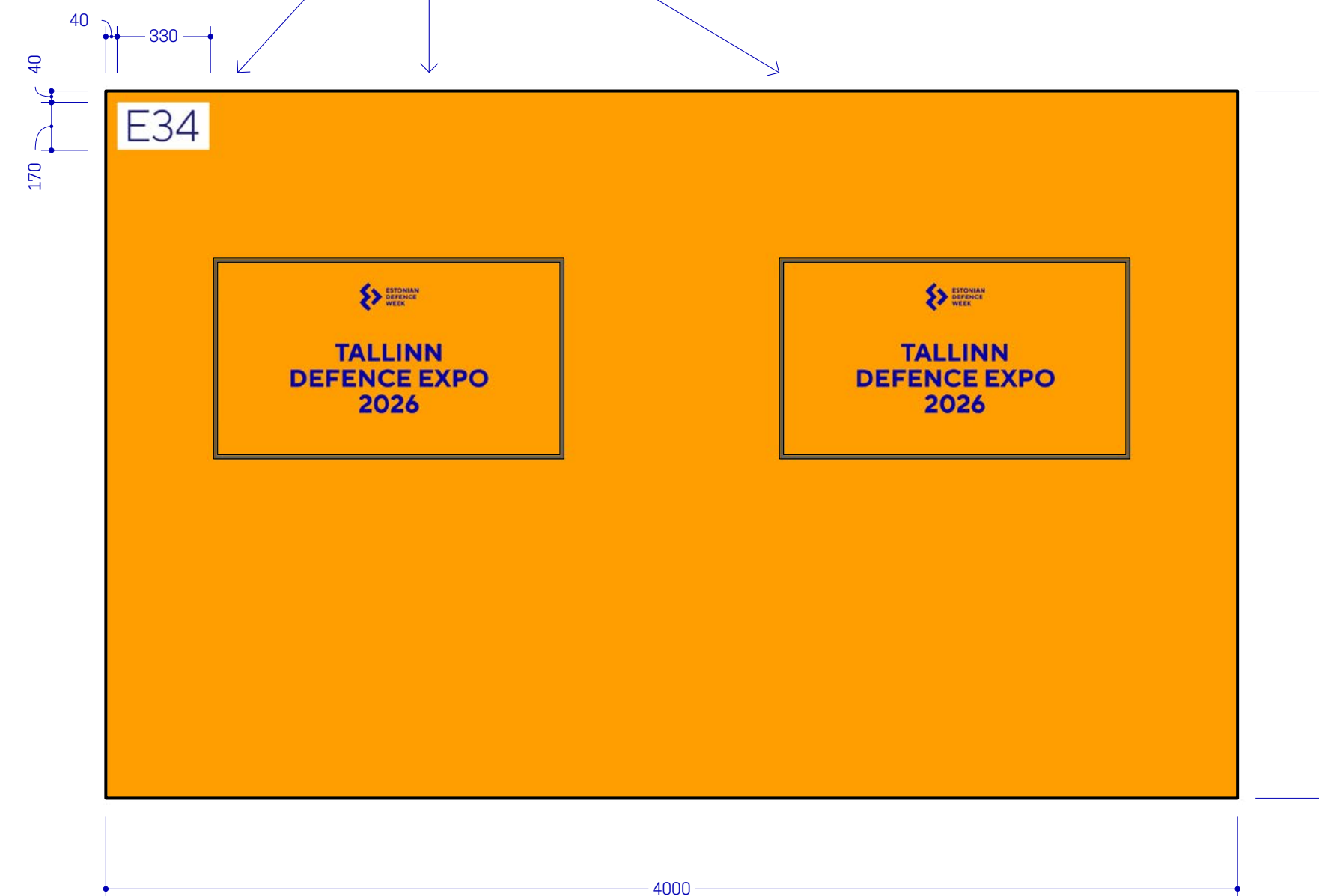

# STANDS

## STANDARD 1 CUSTOM DOUBLE

### STANDARD 1 CUSTOM DOUBLE

All areas marked in orange can be customised with your own graphics.

#### 55" LCD



**Resolution**  
3840 x 2160 (16:9)

**Set Dimension (WxHxD)**  
1238 x 709 mm

**Active Display Area**  
1209.6 x 680.4 mm

#### Exhibition counter

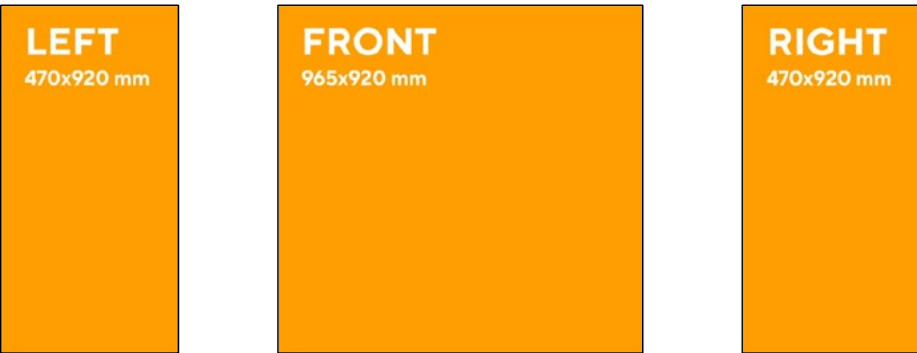

#### Exhibition counter 2

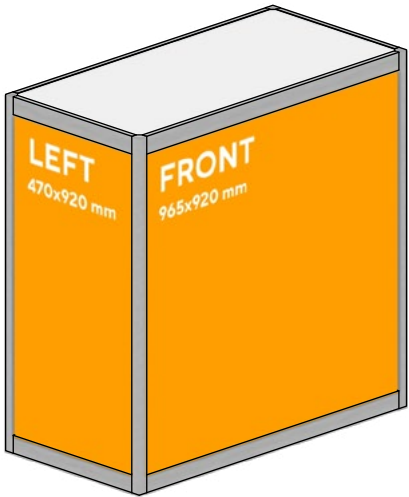

**Important note:**  
All edges of the counter graphics will be inserted approximately 5–7 mm into grooves.  
Avoid placing critical details or small text close to the edges.

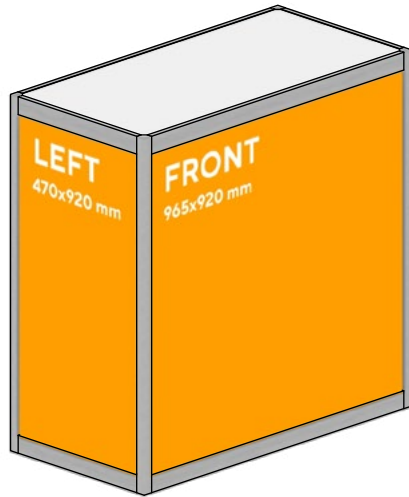

[www.kingent.ee](http://www.kingent.ee)  
A3 / M=1:20

# STANDS

## STANDARD 2

- **Footprint:** 2.0 x 1.5 m
- **Height:** 2.3 m
- **Flooring:** Carpet with protective film
- **Power Supply:** 2 x Schuko sockets, 230 V, 16 A, 1.5 kW
- **Lighting:** LED ceiling lights, 300 lux, 4000 K
- **Exhibition counter:** 1.0 x 0.5 m, height 1.0 m
- **Seating:** 2 bar stools
- **Display:** 55" LCD screen with HDMI connection
- All areas marked in orange can be customised with your own graphics.

### STANDARD 2

All areas marked in orange can be customised with your own graphics.

Iso view

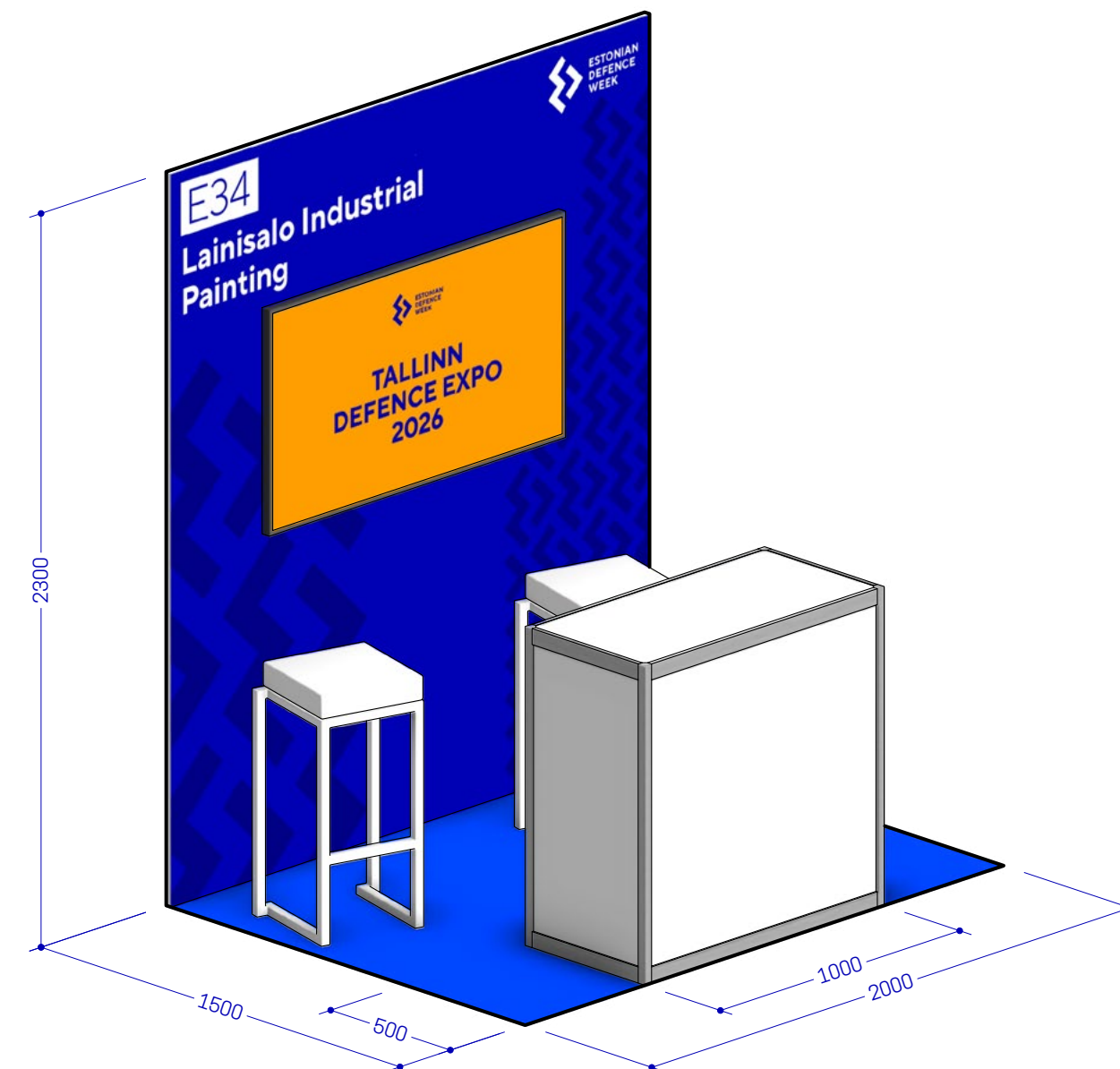

Front view



[www.kingent.ee](http://www.kingent.ee)  
A3 / M=1:20

# STANDS

## STANDARD 2 CUSTOM

- **Footprint:** 2.0 x 1.5 m
- **Height:** 2.3 m
- **Flooring:** Carpet with protective film
- **Power Supply:** 2 x Schuko sockets, 230 V, 16 A, 1.5 kW
- **Lighting:** LED ceiling lights, 300 lux, 4000 K
- **Exhibition counter:** 1.0 x 0.5 m, height 1.0 m
- **Seating:** 2 bar stools
- **Display:** 55" LCD screen with HDMI connection

### Custom graphic design option

Exhibitors may customise designated stand areas (marked in orange) with their graphics. All designs must meet event standards and require approval by the Expo Manager for consistency.

### Important:

The deadline for submitting graphic design files is 12 June 2026.

## STANDARD 2 CUSTOM

All areas marked in orange can be customised with your own graphics.

Iso view

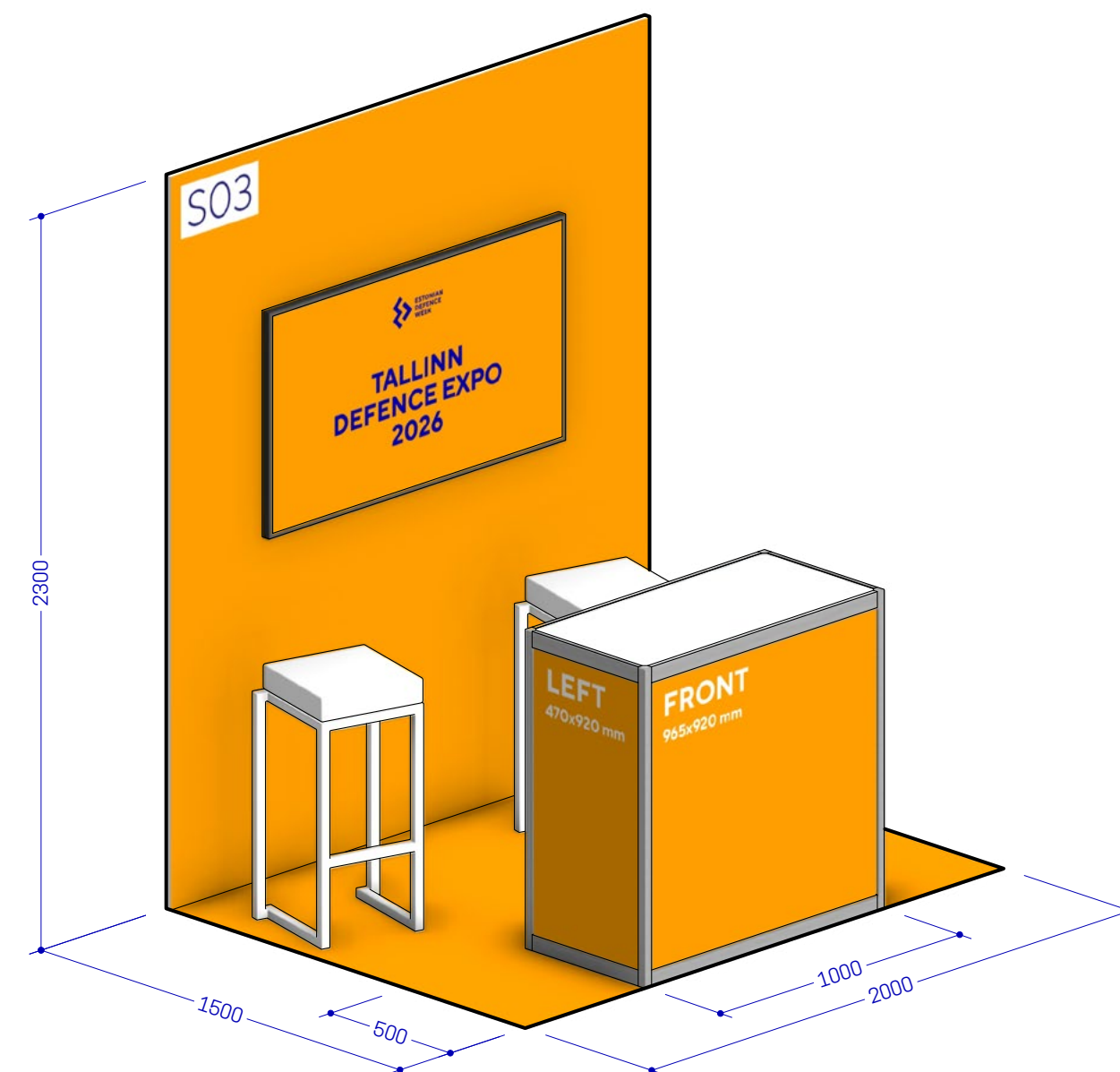

Front view



[www.kingent.ee](http://www.kingent.ee)  
A3 / M=1:20



# STANDS

## STANDARD 2 DOUBLE

- **Footprint:** 4.0 x 1.5 m
- **Height:** 2.3 m
- **Flooring:** Carpet with protective film
- **Power Supply:** 4 x Schuko sockets, 230 V, 16 A, 1.5 kW
- **Lighting:** LED ceiling lights, 300 lux, 4000 K
- **Exhibition counter:** 2 counters (1.0 x 0.5 m, height 1.0 m)
- **Seating:** 4 bar stools
- **Display:** 2 x 55" LCD screen with HDMI connection
- All areas marked in orange can be customised with your own graphics.

### STANDARD 2 DOUBLE

All areas marked in orange can be customised with your own graphics.

Iso view



[www.kingent.ee](http://www.kingent.ee)  
A3 / M=1:20

# STANDS

## STANDARD 2 DOUBLE

### STANDARD 2 DOUBLE

All areas marked in orange can be customised with your own graphics.

#### Front view

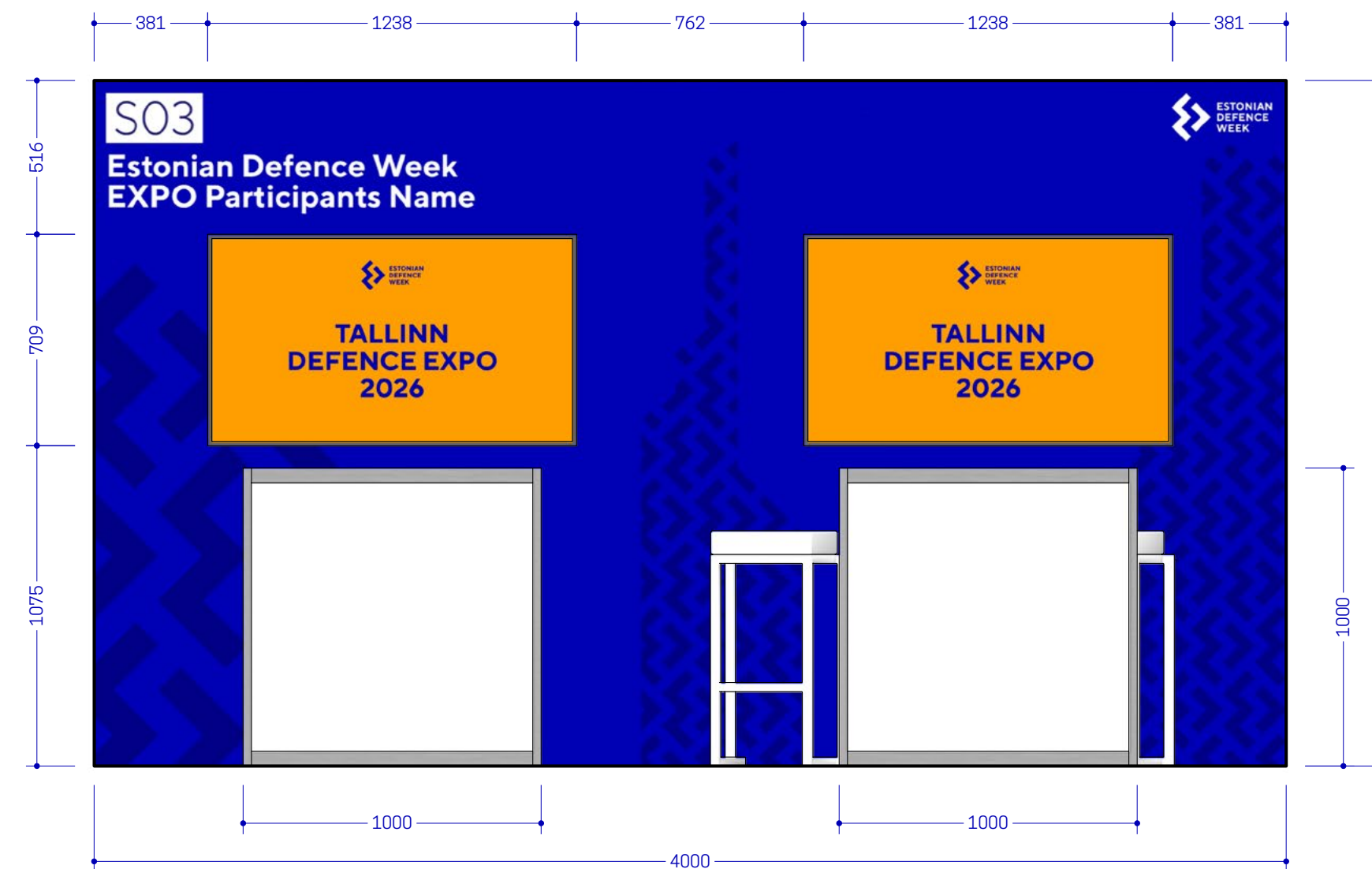

# STANDS

## STANDARD 2 CUSTOM DOUBLE

- **Footprint:** 4.0 x 1.5 m
- **Height:** 2.3 m
- **Flooring:** Carpet with protective film
- **Power Supply:** 4 x Schuko sockets, 230 V, 16 A, 1.5 kW
- **Lighting:** LED ceiling lights, 300 lux, 4000 K
- **Exhibition counter:** 2 counters (1.0 x 0.5 m, height 1.0 m)
- **Seating:** 4 bar stools
- **Display:** 2 x 55" LCD screen with HDMI connection

### Custom graphic design option

Exhibitors may customise designated stand areas (marked in orange) with their graphics. All designs must meet event standards and require approval by the Expo Manager for consistency.

### Important:

The deadline for submitting graphic design files is 12 June 2026.

### STANDARD 2 CUSTOM DOUBLE

All areas marked in orange can be customised with your own graphics.

Iso view

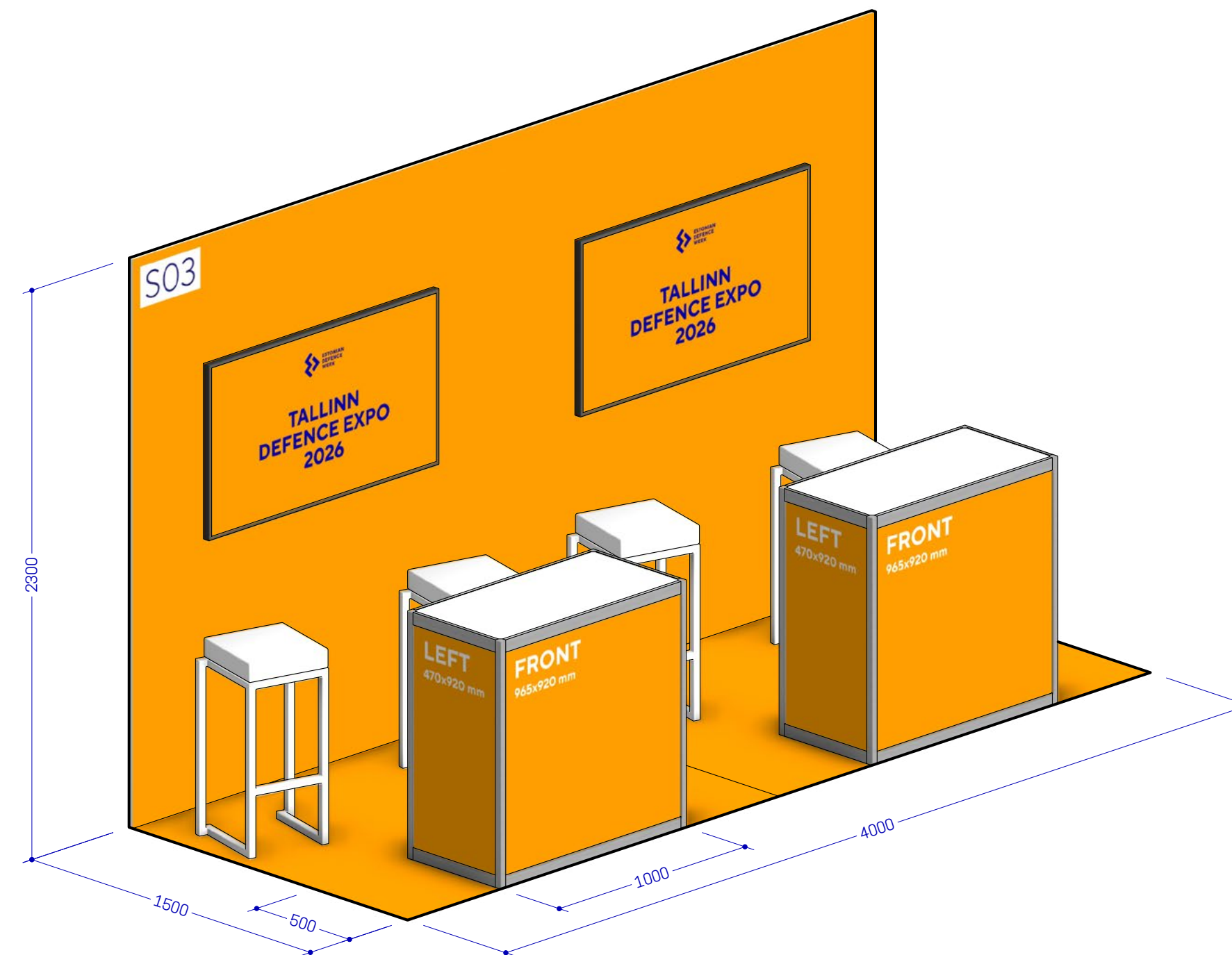

[www.kingent.ee](http://www.kingent.ee)  
A3 / M=1:20

# STANDS

## STANDARD 2 CUSTOM DOUBLE

### STANDARD 2 CUSTOM DOUBLE

All areas marked in orange can be customised with your own graphics.

Front view

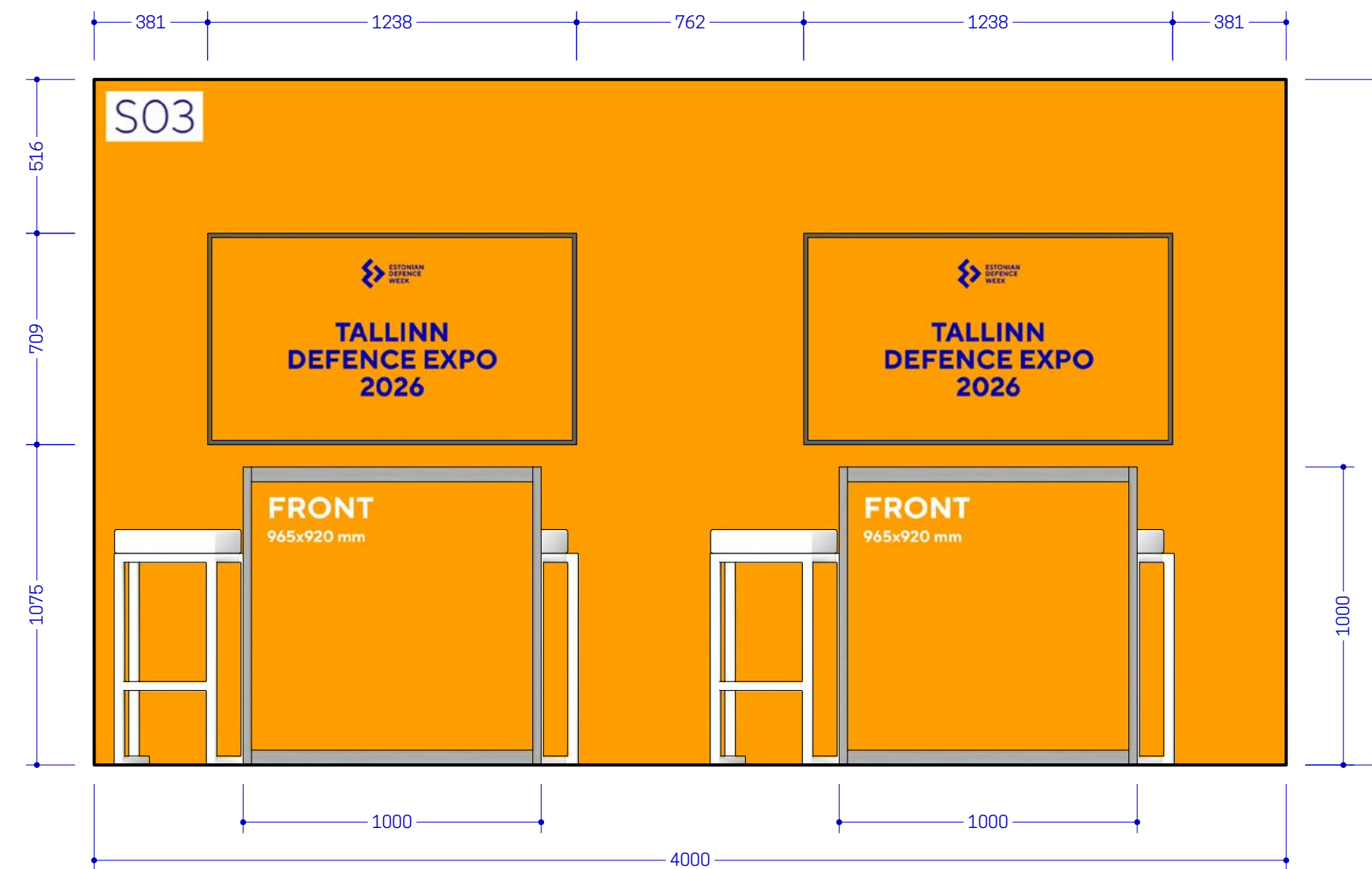

# STANDS

## STANDARD 2 CUSTOM DOUBLE

### STANDARD 2 CUSTOM DOUBLE

All areas marked in orange can be customised with your own graphics.

#### Stand back wall

**NB!** Keep area under stand number and LCDs clear of logos and text.  
Stand number sticker will be applied on-site.

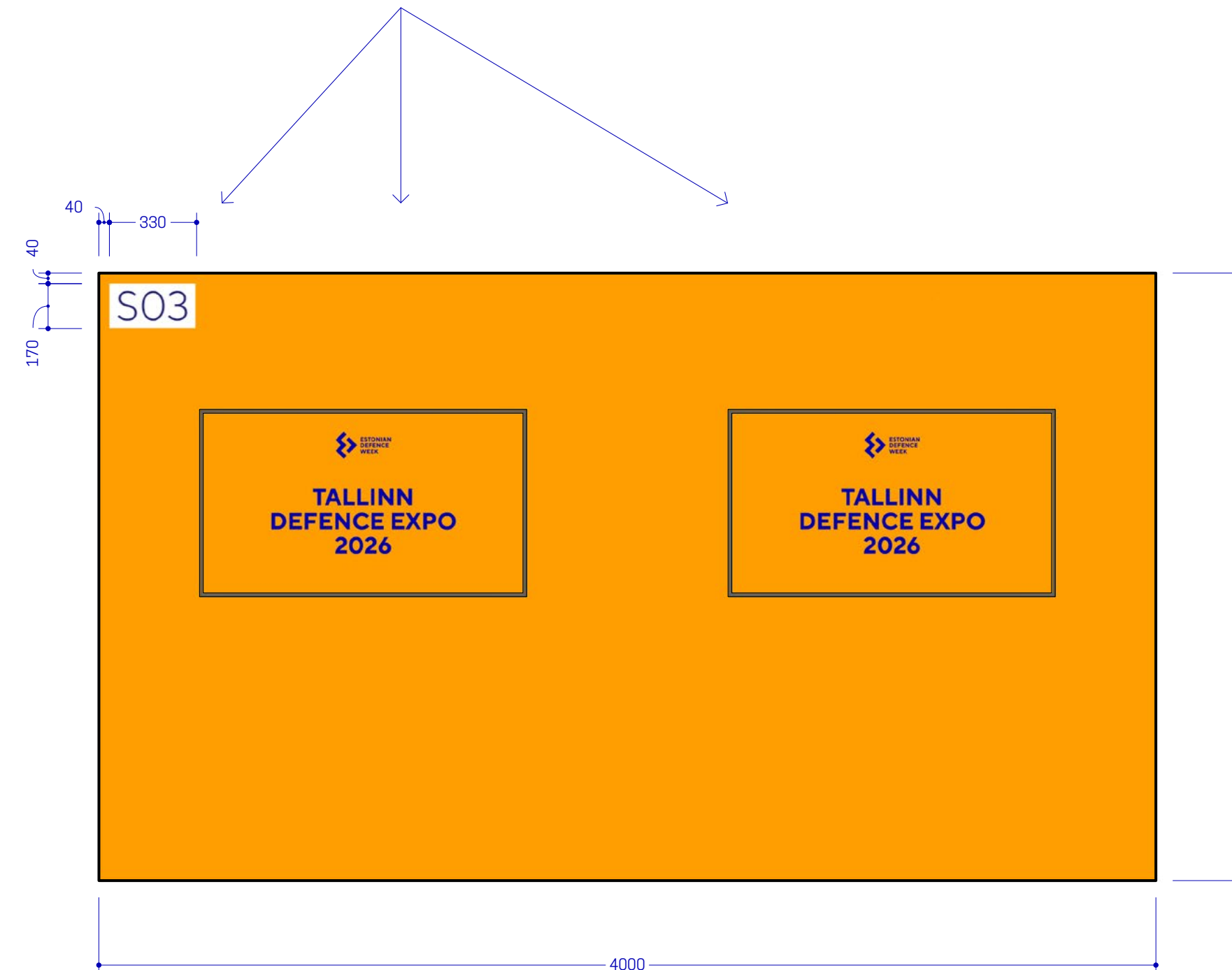

# STANDS

## STANDARD 2 CUSTOM DOUBLE

### STANDARD 2 CUSTOM DOUBLE

All areas marked in orange can be customised with your own graphics.

#### 55" LCD



**Resolution**  
3840 x 2160 (16:9)

**Set Dimension (WxHxD)**  
1238 x 709 mm

**Active Display Area**  
1209.6 x 680.4 mm

#### Exhibition counter



#### Exhibition counter 2

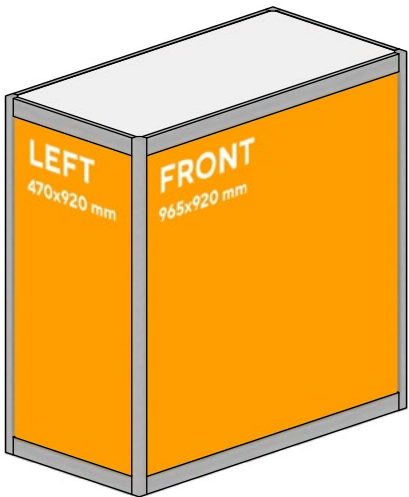

**Important note:**  
All edges of the counter graphics will be inserted approximately 5–7 mm into grooves.  
Avoid placing critical details or small text close to the edges.

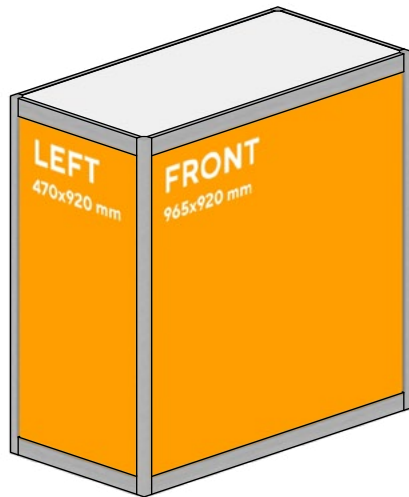

[www.kingent.ee](http://www.kingent.ee)  
A3 / M=1:20

# STANDS

## STANDARD OUTDOOR STAND

- **Footprint:** 3.0 x 6.0 m
- **Surface:** Tarmac
- Load restrictions apply – verification required
- Some stand areas are on sloped ground – check with your Expo Manager for details
- Restrictions may apply when ordering stand equipment for sloped areas
- Tents, levelled flooring, electrical supply, and other stand equipment are available upon request via the Expo Manager (additional cost)

The outdoor area is enclosed by a low fence and is **not accessible to the public**, but remains **visible from a distance**.

**Overnight security** is provided by the organisers.

## HOW TO GET HERE?

The Creative Hub is centrally located in Tallinn and easily accessible by various means of transport:

### Walking

A short walk from Old Town, Viru Gate and the Port of Tallinn.

### Public Transport

Conveniently connected by bus and tram. Both designated stops are just a short walk to the venue.

- Buses: 3, 21, 21B, 41, 41B, 66 (Alight at the “Linnahall” stop).
- Trams: 1, 2, 5 (Alight at either the “Linnahall” or “Suur Rannavärav” stop)

### By Car

Taxis can easily reach the venue.  
Paid parking is available at the nearby Tallinn City Hall parking area

### By Air

The Creative Hub is 6.5 kilometres from the airport.

### Parking:

- at Kultuurikatel:  
<https://kultuurikatel.ee/en/tallinn-creative-hub/how-to-get-here/#parking>
- Parking is available around the venue at designated areas and is subject to local parking fees.
- Please check the signs on-site or refer to Tallinn’s public parking regulations for details.



# DATES & VENUE

## EXPO DAYS

- 21 September 2026
  - Exhibitors load-in
  - DEFENCE INNOVATION DAY 2026
- 22 September 2026
  - DEFENCE EXPO Day 1
  - SYMPOSIUM 2026
  - ABCD CONFERENCE 2026 Day 1
- 23 September 2026
  - DEFENCE EXPO Day 2
  - ABCD CONFERENCE 2026 Day 2
- 24 September 2026
  - DEFENCE EXPO Day 3
  - NATO Open Innovation Challenge (OIC) 2026
  - Exhibitors load-out

## LOCATION

**The Creative Hub (Kultuurikatel), Kursi tn 3, Tallinn 10415**

**Destination PIN:** 59.44436155707877, 24.751323184951033

**Google Maps Link:** Event Venue (<https://maps.app.goo.gl/g9WNYLQK6sftyACS6>)

**Parking:** at Kultuurikatel (<https://kultuurikatel.ee/en/tallinn-creative-hub/how-to-get-here/#parking>)

Parking is available around the venue at designated areas and is subject to local parking fees.

Please check the signs on-site or refer to Tallinn's public parking regulations for details.

# ADDITIONAL SERVICES

EDW EXPO provides additional technical and convenience services for exhibitors. The available services include but are not limited to:

- AV Equipment & Services
- Lighting Solutions
- Furniture, Staging, and Scenic Design
- Event Production
- Photography, Videography & Editing
- Graphic Design
- Support Personnel & Technical Crew
- Catering Services
- Courier Services
- Storage

For details, custom pricing, and to order additional services, contact your Expo Manager:

**Primary Contact - Expo Manager:**

Merlyn Paomets  
merlyn@kingent.ee  
+372 5840 0583

**General Office & Backup:**

Kingent Management  
expo@kingent.ee  
+372 5557 5318  
www.kingent.ee